

SAFETY SLATTED AUTOMATIC COVER

# moove'O



**INSTALLATION NOTICE**

Installation / Use / Maintenance / Safety Advice

SWIMMING POOL DEVELOPMENT AND INNOVATION



**THIS NOTICE MUST BE GIVEN TO THE POOL OWNER  
PLEASE READ CAREFULLY AND KEEP IN A SAFE PLACE**

## PARTS INCLUDED IN THE DELIVERY

### Moove'O

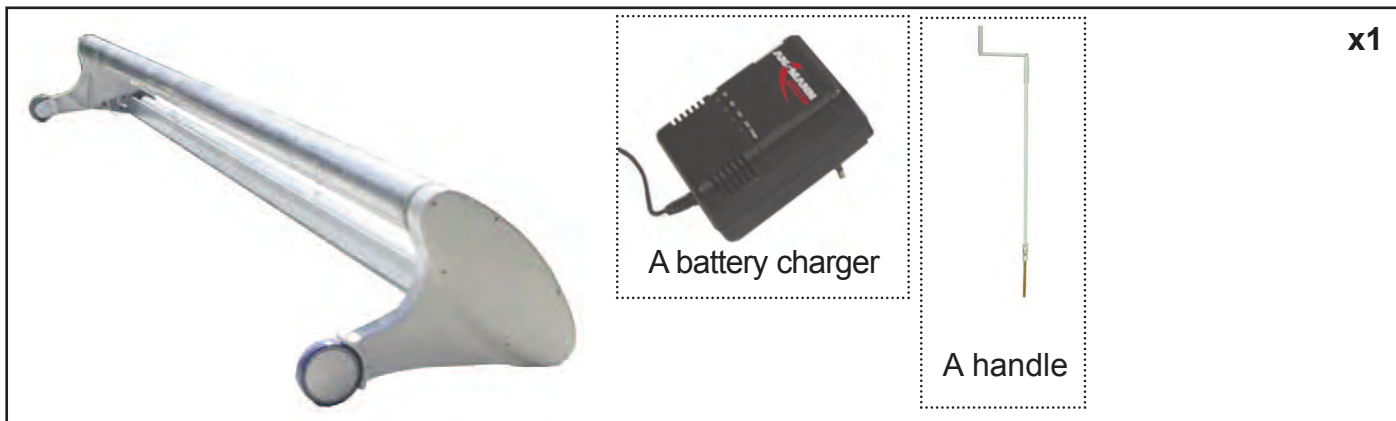

**69 mm Slats** « number of boxes according to your order »



### Safety kit (1 box ) - OPTION

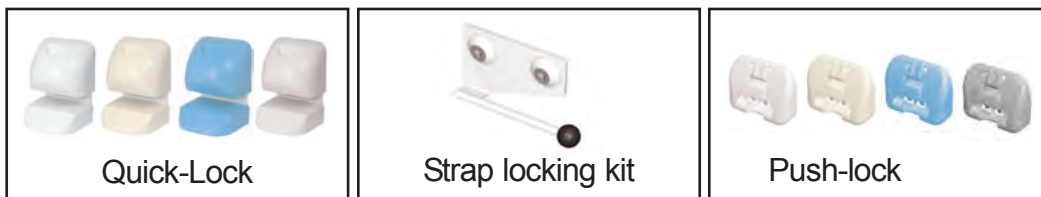

*3 fitting models: surface mounted - insert mounted- hanging mounted*

## PACKING LIST

**example - for a 5 x 10 m pool with Ø3 m step unit**



Moove'o + safety kit : 1 box of 0.80 x 0.70 x 5.50 m --- 90Kg

Slats : 5 box of 5 x 0.25 x 0.20 m --- 190 Kg

**Peso weight : 280 Kg**

## TRANSPORT



In any event the consignment must be checked by the recipient upon receipt of the delivery. Any damage or shortage should be reported to the supplier within 24 hours.

## NECESSARY TOOLS - (INSTALLATION - 2 PERSONS)



## INFORMATION/PLACE/AXLE HEIGHT

The cover is made of watertight PVC slats that float on the water. The opening and closing of the cover is made with the use of the key situated on one of the support of Moove'O.

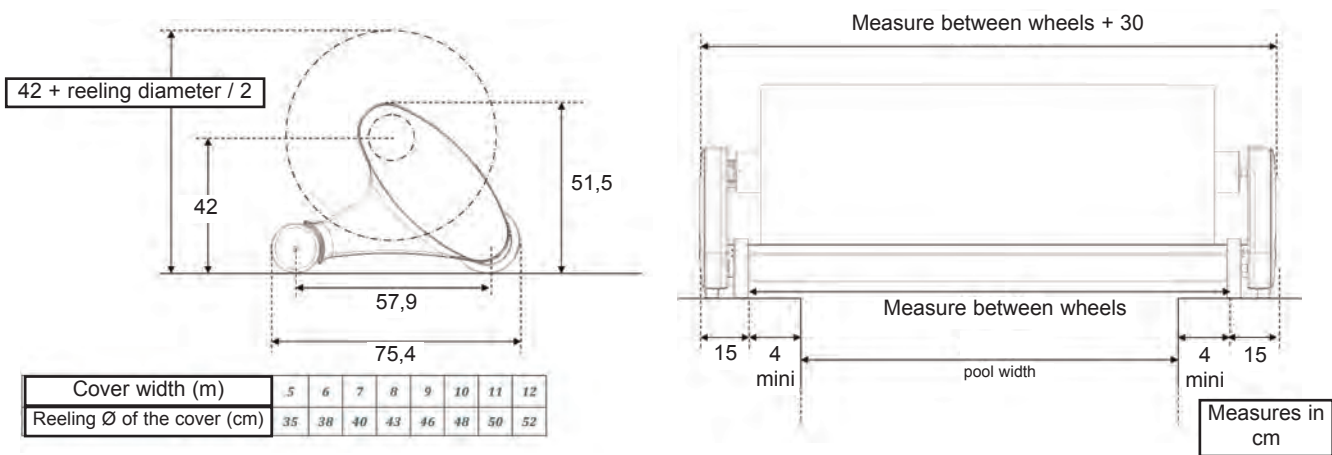

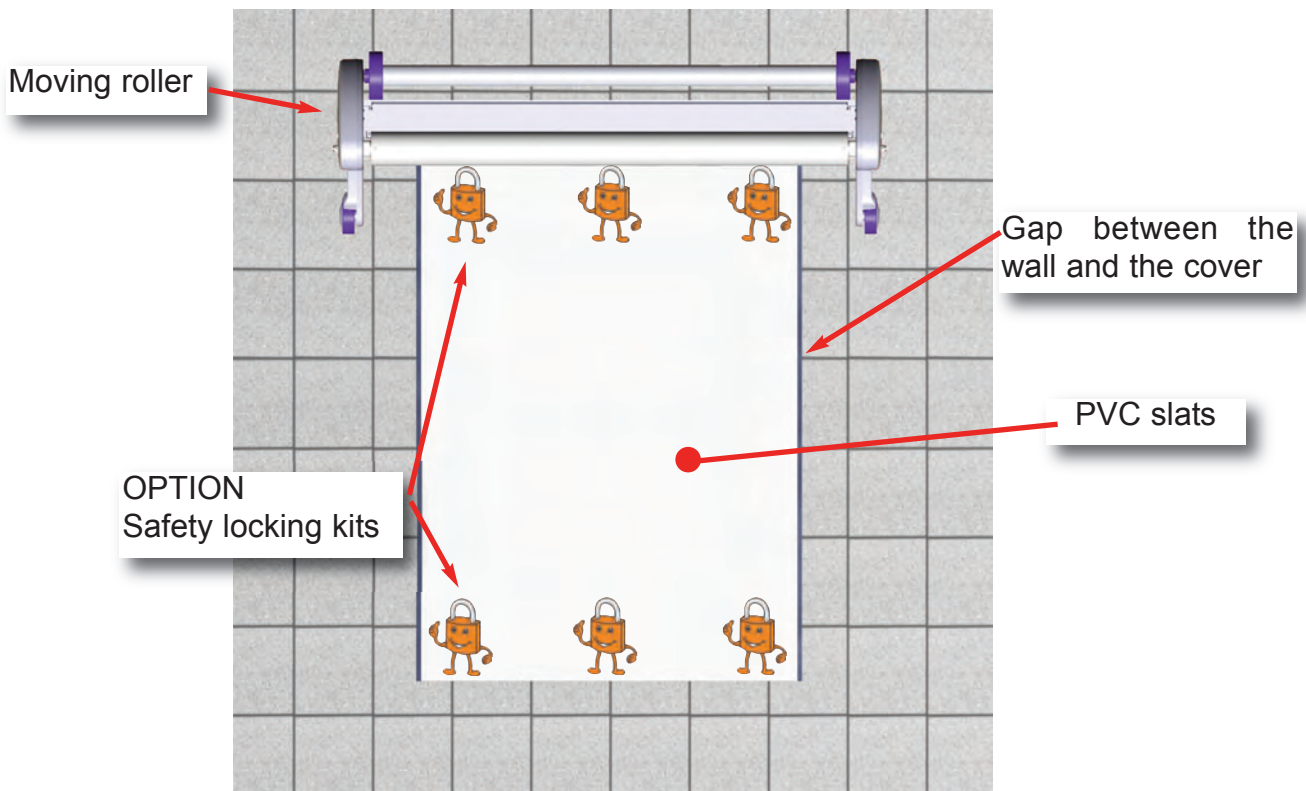

## THE COVER



To date, covers for overflow pools and covers with removable step unit on the side are not conform with NF P 90-308 French safety norm. Unless indicated by the manufacturer, immersion alarms are not compatible with DEL automatic covers.

## INSTALLATION

 This surface must be flat and resistant enough to bear the weight and move of the Moove'O (not recommended on lawns)  
Maximum weight 340kg

  These surfaces must not have any obstacles over 6.5cm high. Mind the filtration unit and shapes of the coping stones

 Moove'O can be moved in straight lines only

 The Moove'O is centered on the pool

The Moove'O must be installed according to the corners of the pool

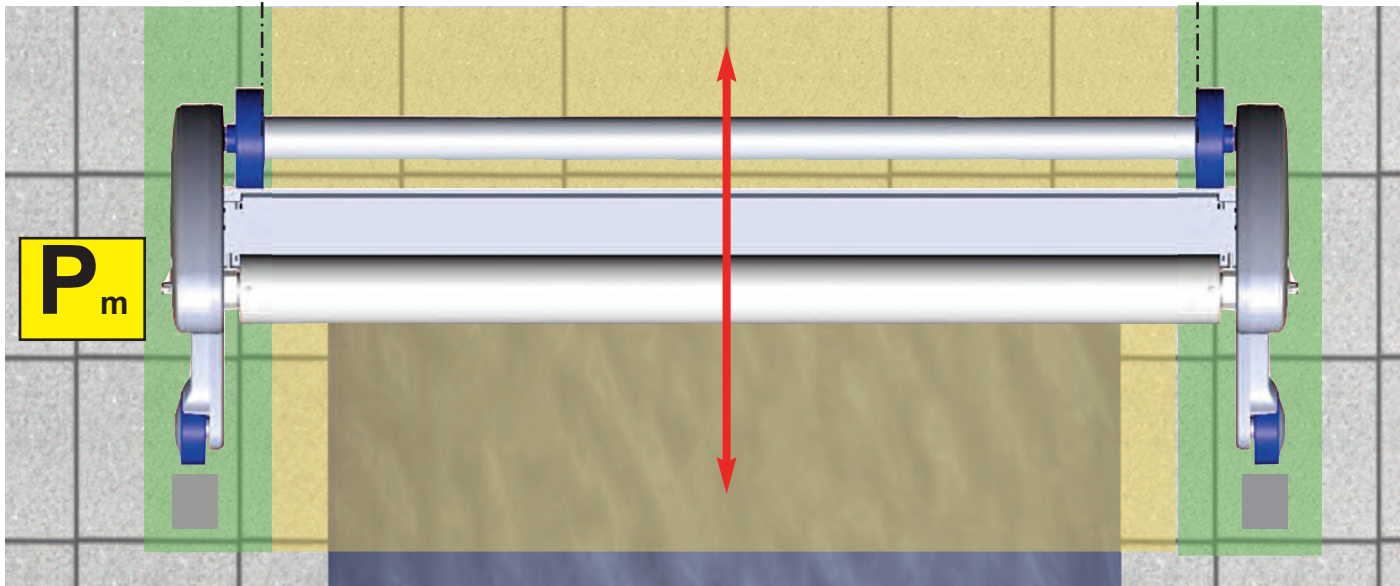
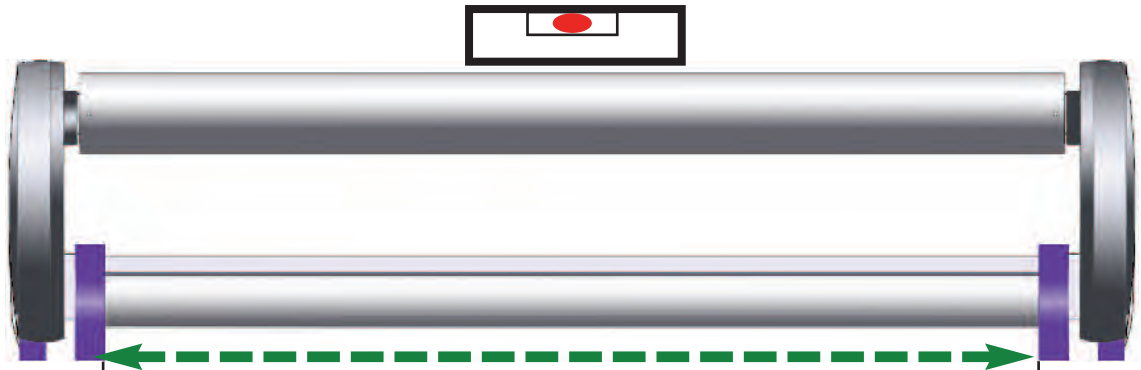
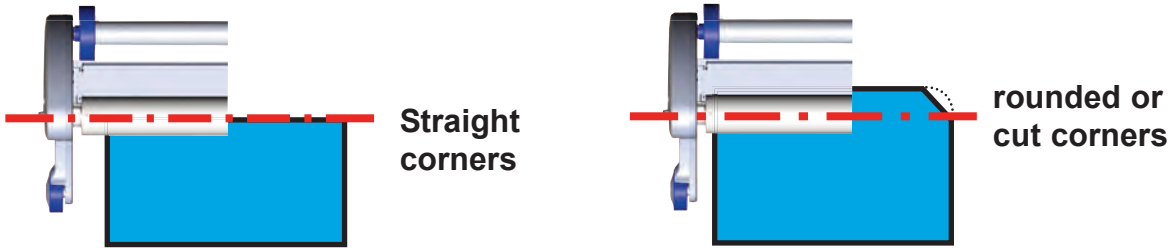

 **P<sub>m</sub>** Position of use  
P<sub>m</sub>. To carry out closing and opening manoeuvres, install the Moove'O on the largest width of the pool

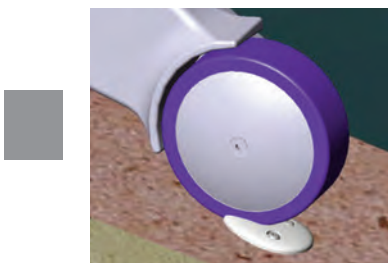

Blocking of the front wheels – enables to know easily the exact position where the opening and closing of the pool have to be

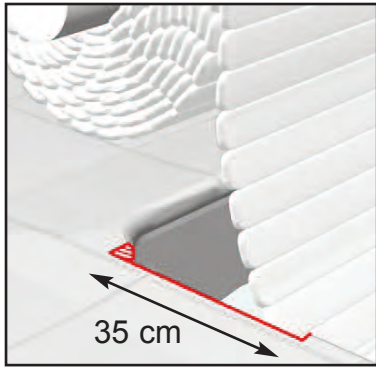

If necessary, cut the coping stones to ease the cover and avoid rubbing.  
 With free shaped pools or pools with big radius (drawing on the left handside), a bigger cut might be necessary.

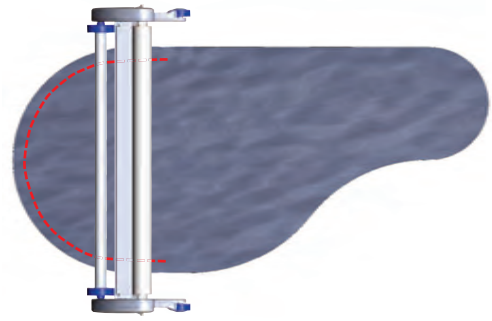

### WIRING

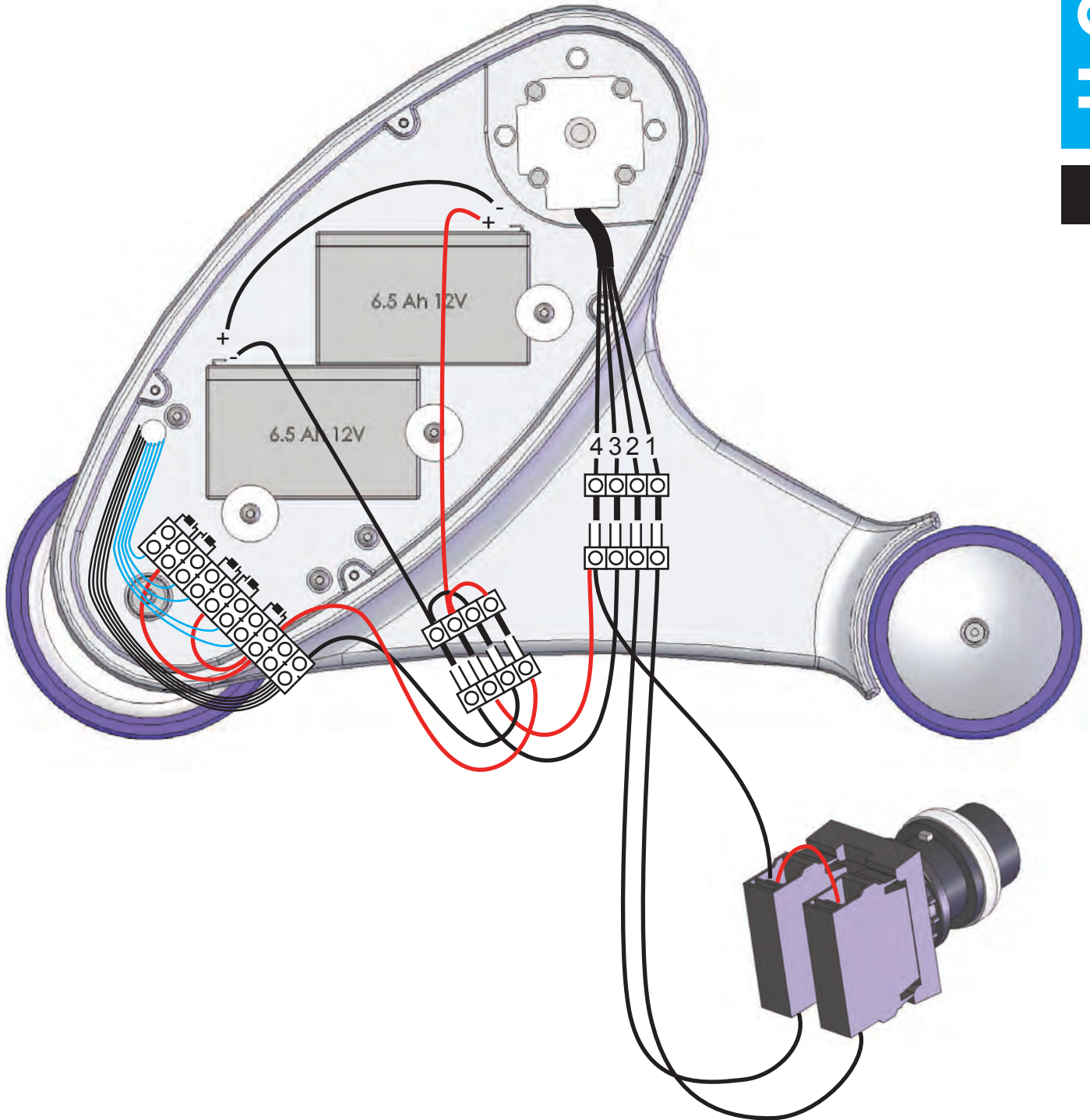

## COVER INSTALLATION



The surface has to be clean and dry

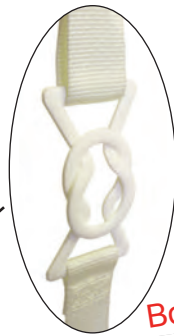

Install the slats on the water and clip them together. Take care with the direction of the cover over the pool.

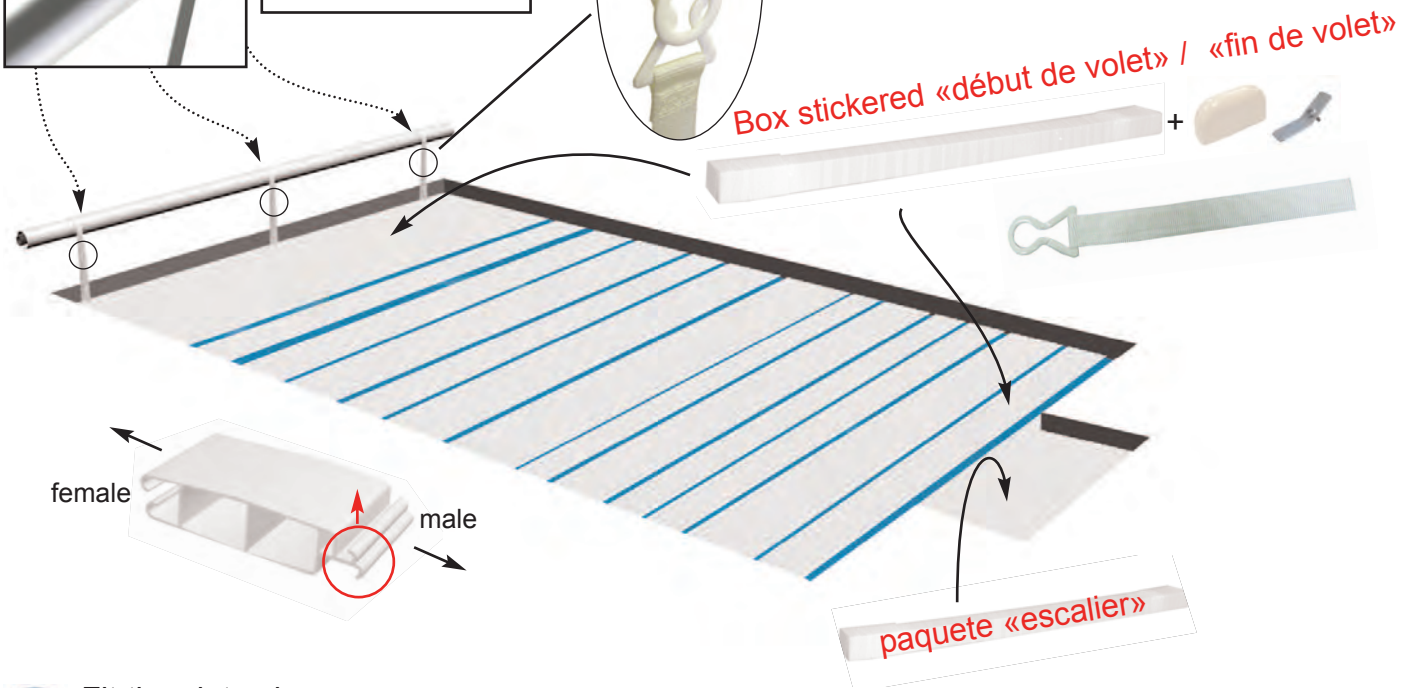

6

**i** Fit the slats along the whole length.



**i** Repeat wiggling/handling of the slats may be needed.

## SKI INSTALLATION

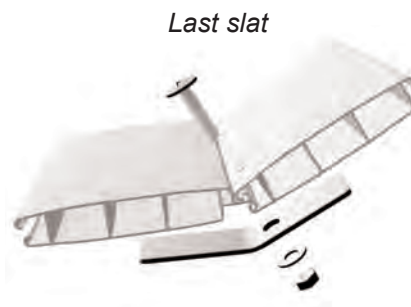
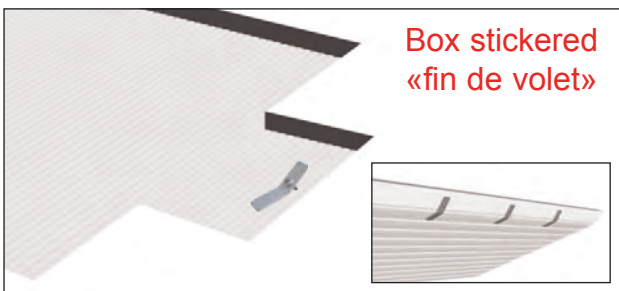

**i** Skis are always mounted on the last slat. They stop the cover «diving» when closing over the pool.

## HOW TO TAKE OFF A SLAT AND END CAPS ?

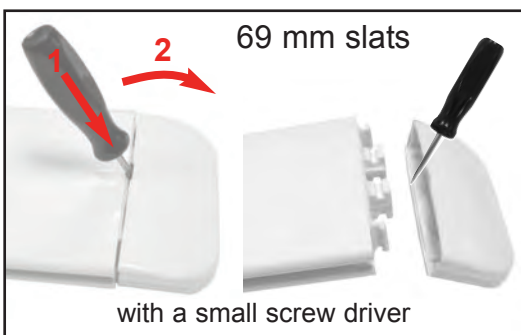

# AUTOMATIC STOP ADJUSTMENT

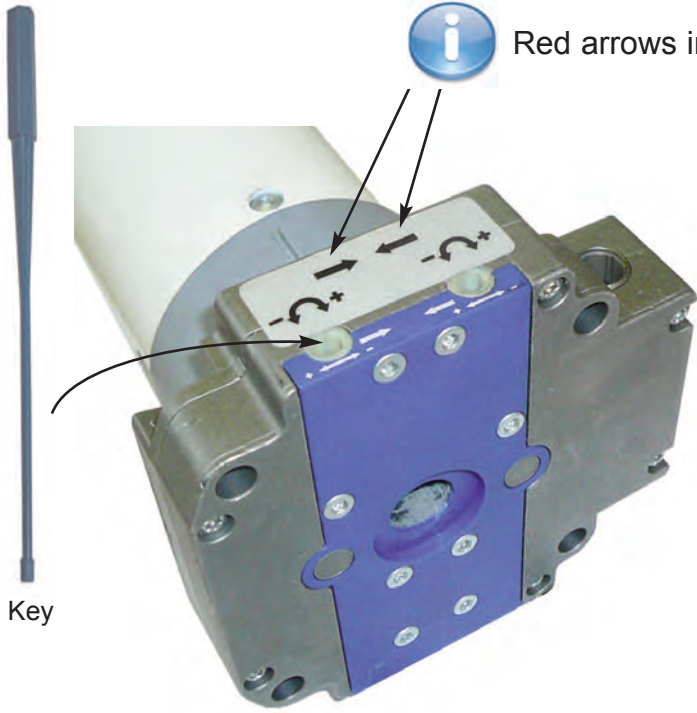

Key

**i** Red arrows indicate the direction of the cover.



Turn the key in the + direction to increase the movement in the direction of the arrow.

Turn the key in the - direction to decrease the movement in the direction of the arrow.

## SAFETY KIT (OPTION)

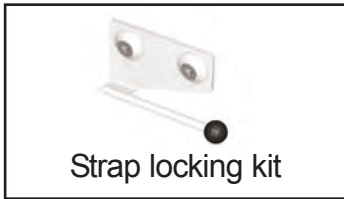
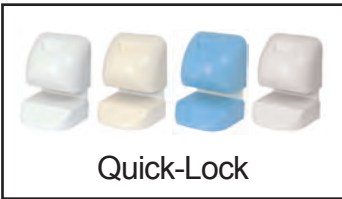

## LOCKING KIT POSITIONING

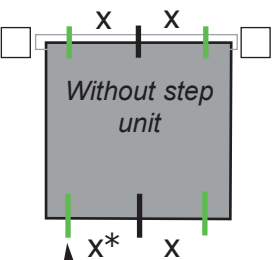

kit at 50 cm from the edge

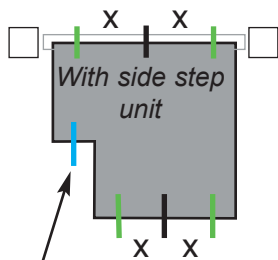

1 kit centred if < 1 m  
1 kit at 50 cm from the edge if < 2 m  
2 kits if > 2 m

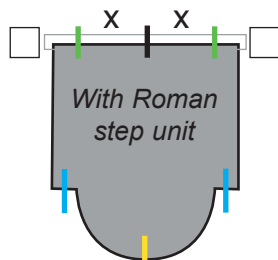

kit at the end of the step unit

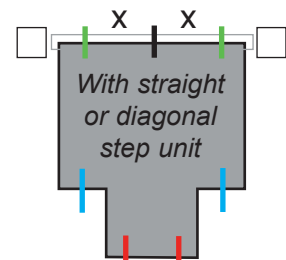

2 kits at 50 cm from the edge

**!** \* X must not exceed 2 m



**Quick Lock and Lock it cannot be installed on cut sides and rounded shapes, except for the Roman end step unit.**

## PUSH-LOCK INSTALLATION

**A water top level is mandatory**

### Insert mounted model

For concrete pools

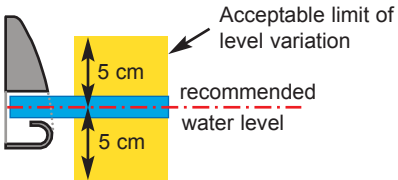
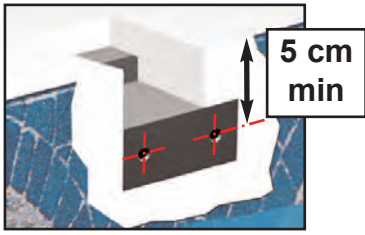

Screw VBA TF Z pozi inox A4 Ø6 x 60

Washer Ø16

Wall unit

Screw cap

### Hanging mounted model

For concrete and panel pools

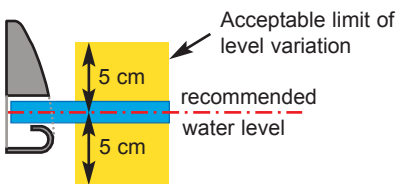

Hanging support

Screw Inox A4 M10 x 60

Washer Ø10

Sleeve nylon Ø12

Bolt A4 M10

Screw cap

### Surface mounted model

For concrete pools and pools with a wall thicker than 8mm.

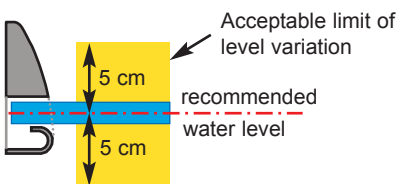
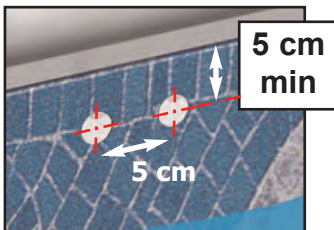

Screw VBA TF Z pozi inox A4 Ø6 x 60

Washer Ø16

Sleeve 8 x 40

Screw cap

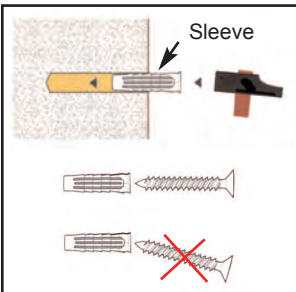
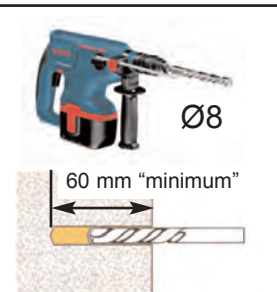

### Concrete

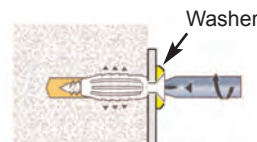

Do not tighten the screws after the resistance point, you could damage the installation.

### Concrete blocks

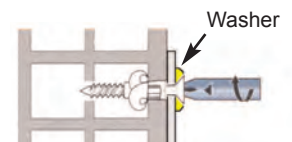

Once the resistance point has been reached, turn the screw 3 times to finish the installation.



**A water top level is mandatory.**

**Insert mounted version**

For concrete pools

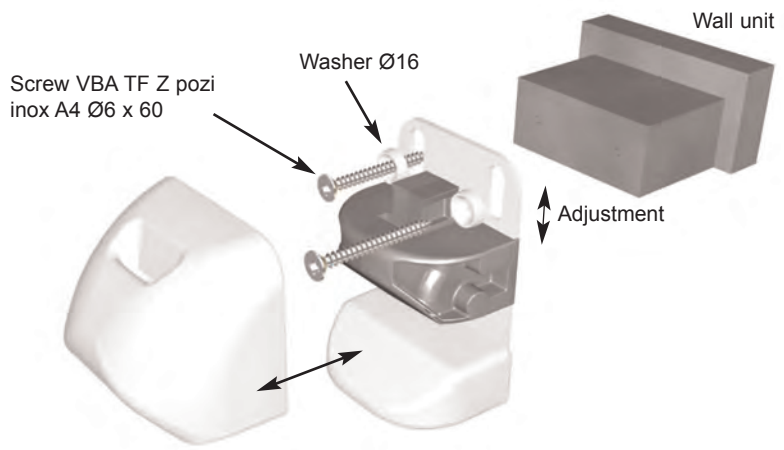
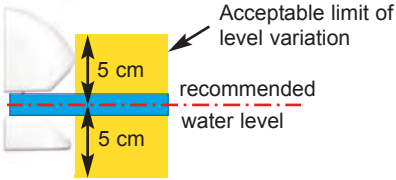
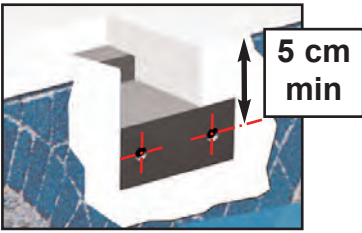

**Hanging mounted model**

For concrete and panel pools

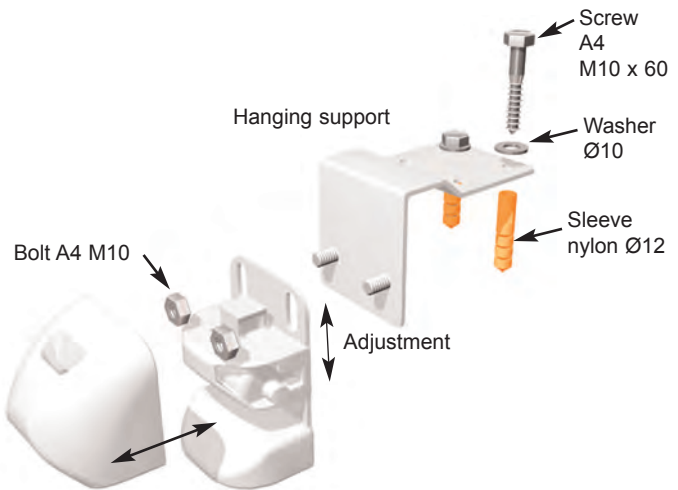
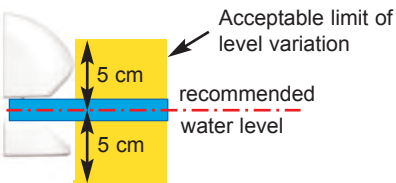

**Surface mounted model**

For concrete pools and pools with a wall thicker than 8mm.

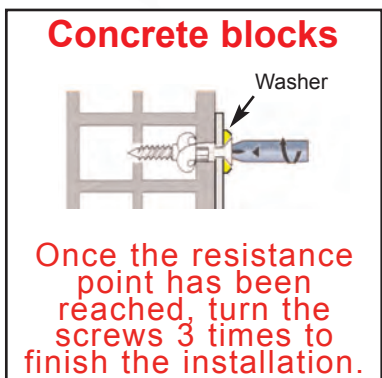
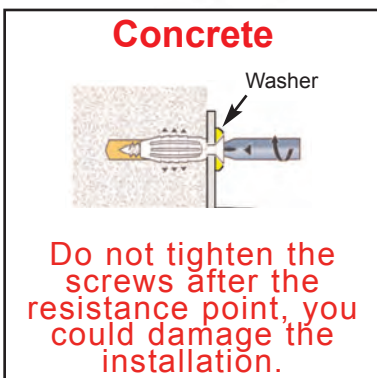
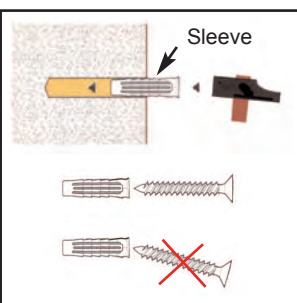
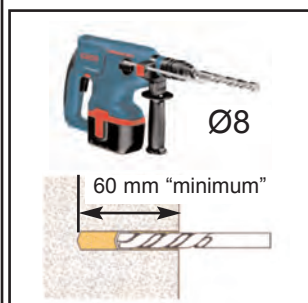
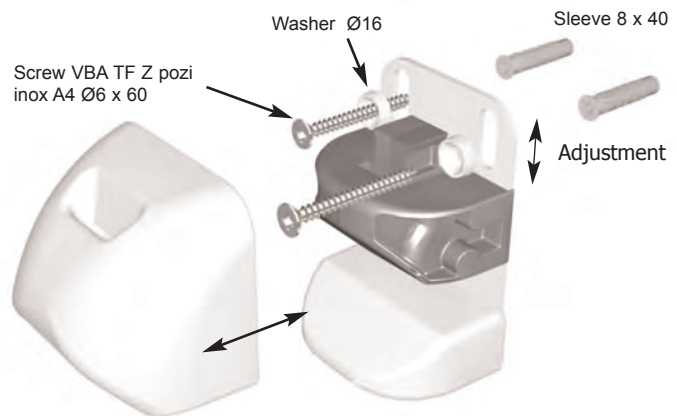
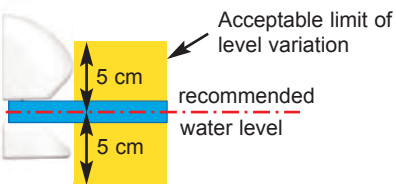
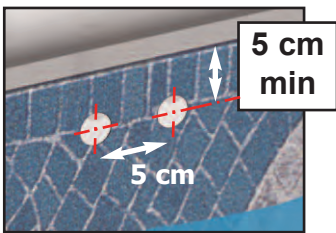

## STRAP INSTALLATION

**A water top level is mandatory.**

### Insert mounted model

For concrete pools

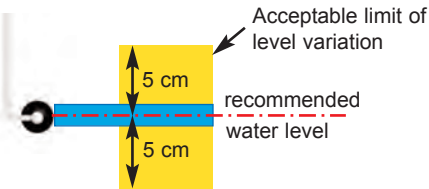
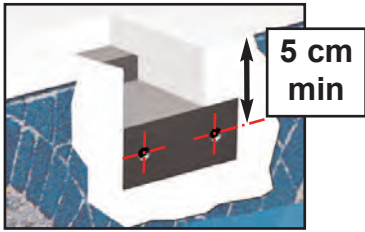

Screw VBA TF Z pozi inox A4 Ø6 x 60

Washer Ø16

Wall unit

### Hanging mounted model

For concrete and panel pools

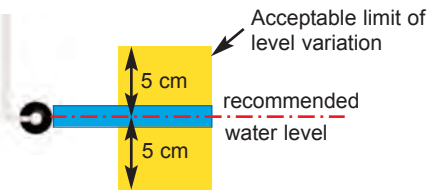

Screw Inox A4 M10 x 60

Washer Ø10

Sleeve nylon Ø12

### Surface mounted model

For concrete pools and pools with a wall thicker than 8mm.

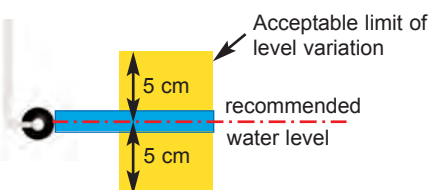
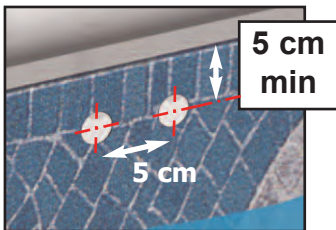

Screw VBA TF Z pozi inox A4 Ø6 x 60

Washer Ø16

Sleeve 8 x 40

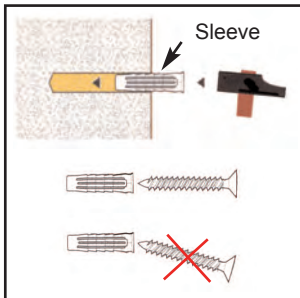

### Concrete

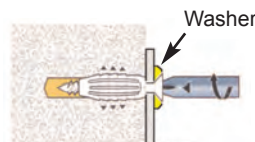

Do not tighten the screws after the resistance point, you could damage the installation.

### Concrete blocks

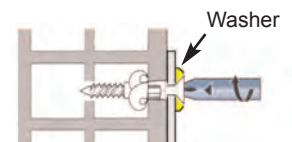

Once the resistance point has been reached, turn the screws 3 times to finish the installation.

## INSTALLATION OF THE STRAP ANCHOR

### Anchor for concrete deck



Ø20

Depth: 5 cm

The anchor head must be higher than the pool deck surface

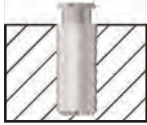

**Do not force the anchor in a hole where the diameter is smaller.**

### Anchor for wood deck



Screw Ø4 x 25



Ø20

Depth : 4,5 cm

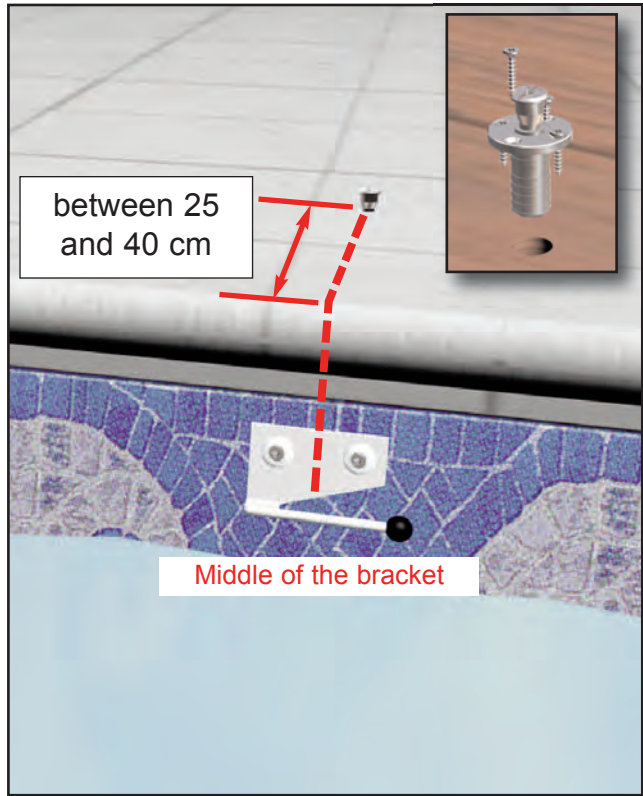

## INSTALLATION OF THE STRAP

Single strap



Double strap



or

tube side

+

+

+

Sheath



Buckle



Hook

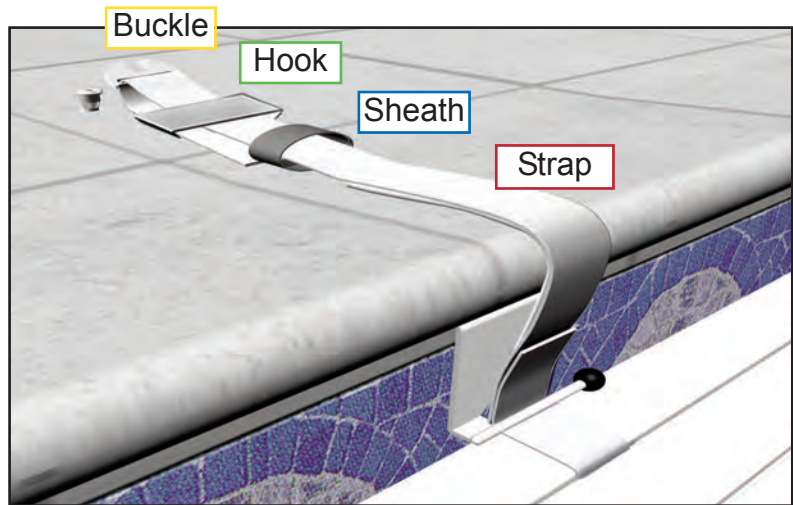

1

**Tense the strap**

*The cover must be under the bracket.*

2

**Install the hook after the buckle and tighten.**

*2 thicknesses of the strap go through the hook.*

3

**Install the sheath around the hook and heat with a hot air gun.**

*thermostat 5 to 6*



**Do not burn the strap.**

1

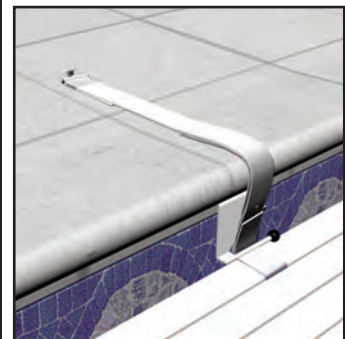
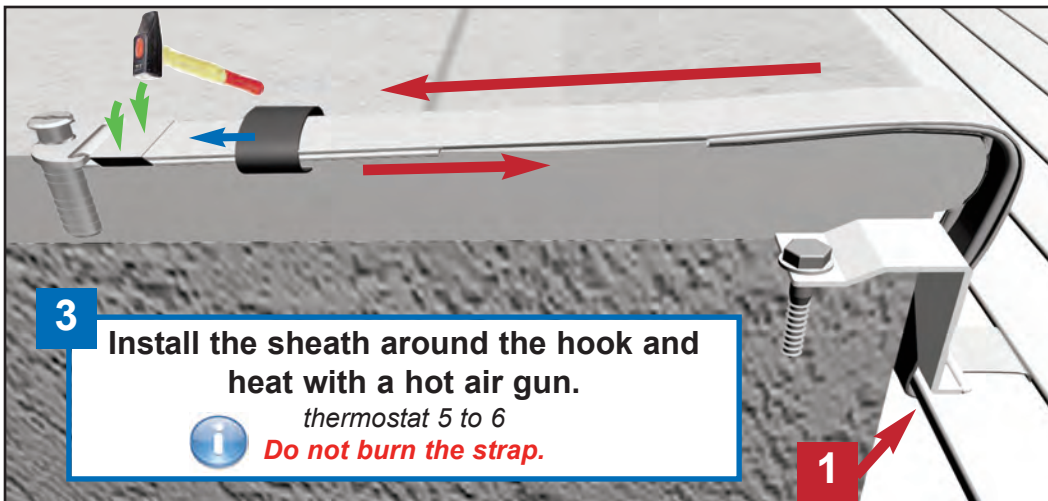

## OPENING/ CLOSING OF THE POOL

- Make sure there is no bather or foreign bodies in the pool before and during the closing action.
- When using an automatic cleaner under the cover, check that the hose does not affect the movement of the slats when opening and closing the cover.
- It is essential to remove floating objects when opening and closing the cover.
- Do not resist the cover when opening and closing it.
- Do not activate the automatic cover when it is frozen / stuck.
- The cover can be opened and closed by one person. (3 minutes)

### Opening :

- Position the Moove'o (in line with the shape of the pool) and tie the cover to the roller (straps with removable connection)
- Release all safety locking kits
- Turn the key switch.
- Move the Moove'o back
- Keep away the items required to activate the cover (e.g. the key) out of children's reach.



**Always release the cover before starting the motor**

### Closing :

- Position the Moove'o (in line with the shape of the pool)
- Turn the key switch «maintained contact during the closing»
- Lock all safety locking kits.
- Untie the cover with the Moove'o
- Move the Moove'o back.
- Keep away the items required to activate the cover (e.g. the key) out of children's reach.



**ALWAYS KEEP AN EYE ON THE POOL DURING OPENING OR CLOSING OF THE COVER.**

# LOCKING AND RELEASING PUSH-LOCK

## Locking

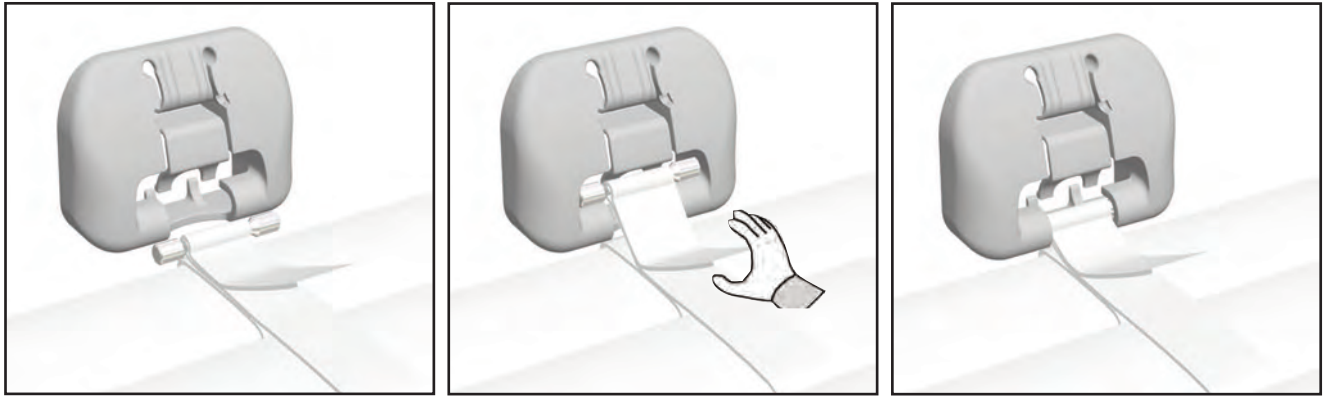

## Releasing

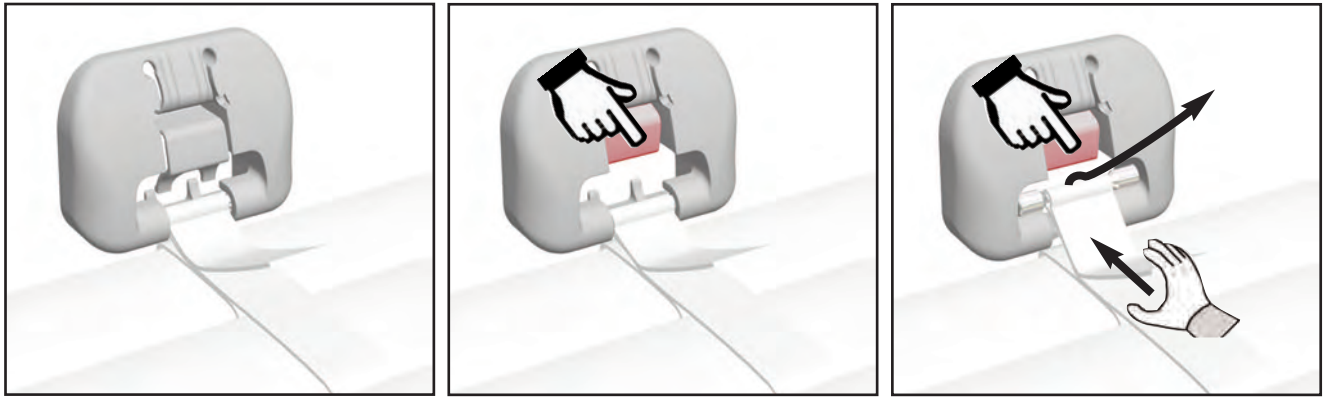

# LOCKING AND RELEASING STRAP SAFETY KIT

## Locking

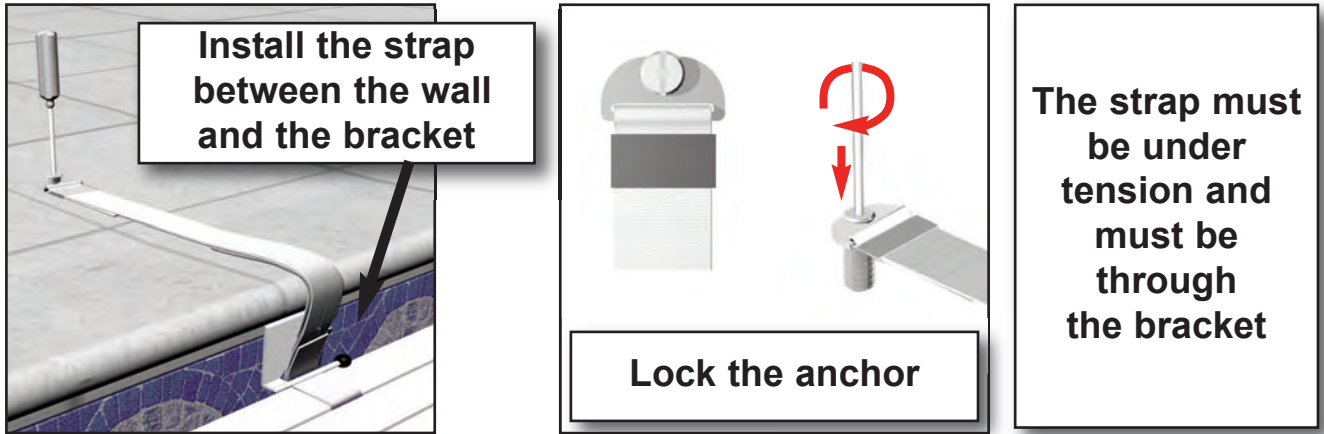

## Releasing

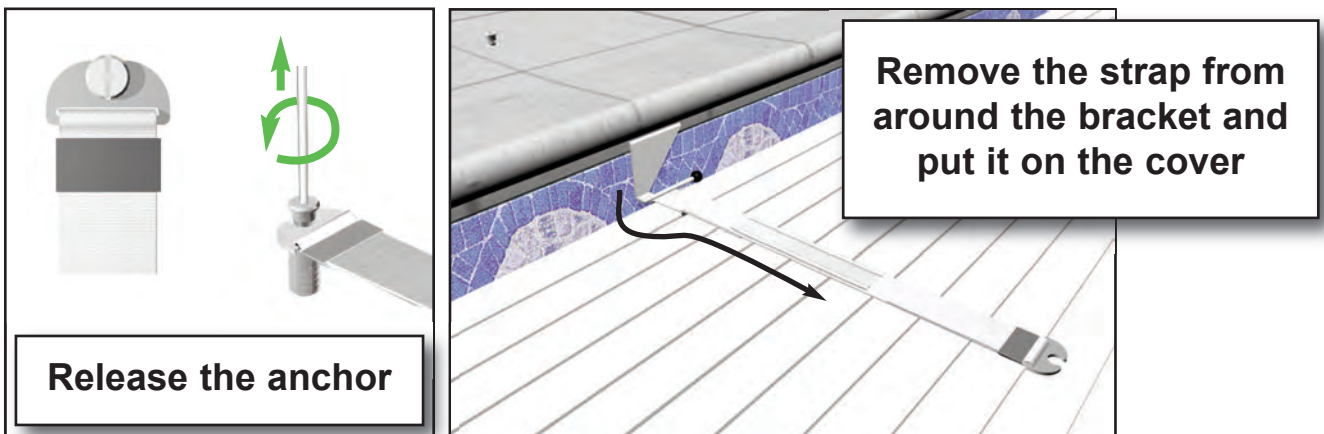

Locking

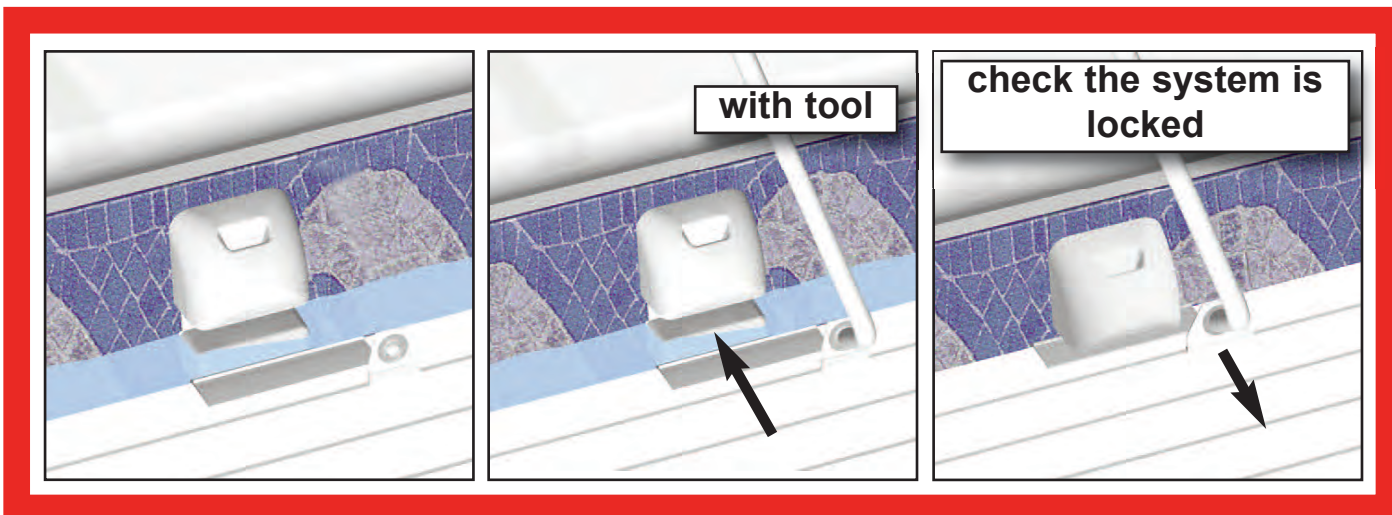

Releasing

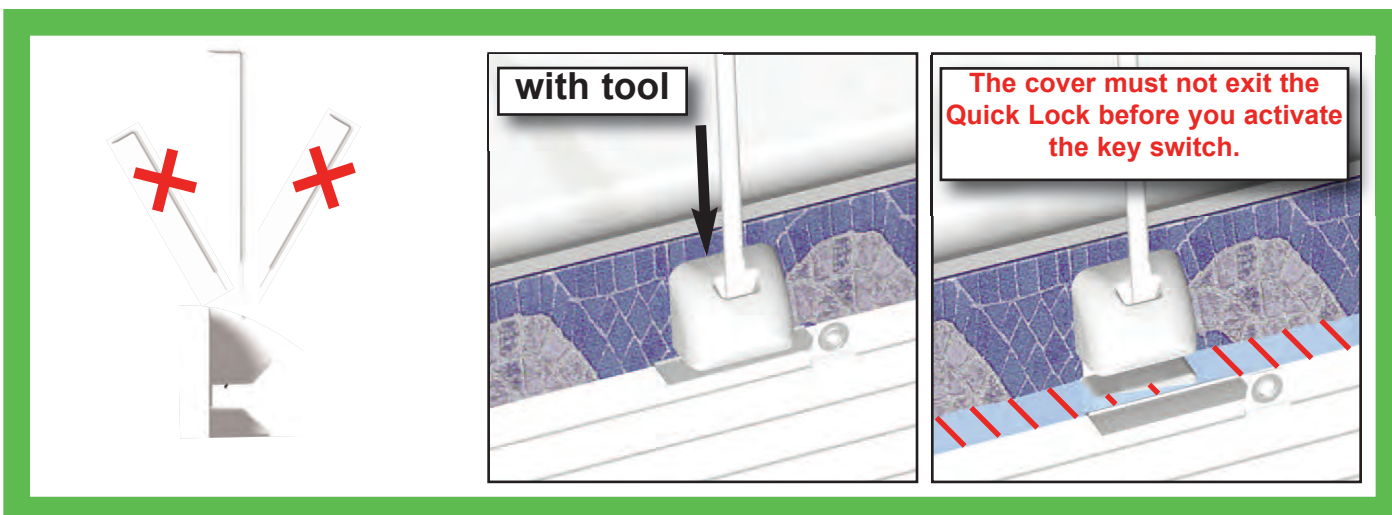

FILTRATION

- Program the filtration during sunlight hours and run it continuously as soon as the water reaches 25°C.

WATER LEVEL OF THE POOL

- The water level has to be maintained at the correct level to avoid damage and repeated activation of the torque limiter device. (For more comfort, use a water level regulator).
- If the water level is too high, it might come from leaves in the skimmer.
- If the water level is too low, it might cause malfunction of the cover.
- In case of hand rails, the pool must be equipped with a water level.

MANUAL HANDLE

Its use does not change the automatic stops adjustment.

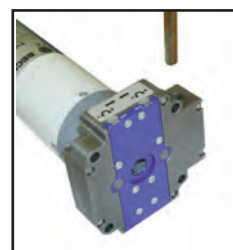

## UPKEEP

- Clean your cover fully twice a year (start of season and start of winter). This is even more important if you have hard water. If this is the case, use a high pressure cleaner with warm water and a descaling product.
- Take the same care to clean the locking systems regularly.
- It is advisable to inspect the whole system, in the event of abnormal force on the cover. (e.g. somebody falling)
- Check the straps every year.

## BATTERIES



AT FIRST SIGHT OF LACK OF POWER RECHARGE THE BATTERIES.  
**NEVER DISCHARGE BATTERIES COMPLETELY.**

**For security reasons, remove the batteries from the roller to recharge them in a dry place.**

Remove batteries from Moove'O (in the support with key switch)

Connect the battery to the charger (be careful with polarity). It starts automatically with appropriate voltage and charging begins. The red LED indicates the batteries are being charged. Charging is completed when the red LED is off. (see charger notice).

Note: Keep the charger in dry place.

## MAINTENANCE

- All work must be carried out by a professional who will contact the manufacturer if necessary.
- All spare parts must be originals.
- Inspect the whole cover for damage/wear and tear.
- It is necessary to check at the start of every season and in the case of accidents (dropping something on it, hail on the cover, abnormal force on the cover, etc.) that the slats have not been visibly damaged in such a way as to affect the cover's operation (slats with cracks, holes, deformations, etc.). Change the slats or the whole cover if necessary.
- In both summer and winter, do not cover the slats with a debris winter cover. "There is a risk of damaging the slats due to a rise in temperature."
- Check the straps (sewing) and the anti-abrasion sheath. Replace the strap or sheath if necessary.

## WINTER

- Prepare the pool for winter according to its geographic location
- Close the cover in safety position.
- Place the battery in a dry and airy place.

DEAR CUSTOMERS :

THANK YOU FOR CHOOSING A DEL AUTOMATIC COVER.

PLEASE READ CAREFULLY THE RECOMMENDATIONS BELOW

## S A F E T Y   N O T I C E

CHILDREN CLOSE TO A SWIMMING POOL REQUIRE YOUR CONSTANT VIGILANCE AND YOUR ACTIVE MONITORING, EVEN IF THEY CAN SWIM.

THE PHYSICAL PRESENCE OF A RESPONSIBLE ADULT IS ESSENTIAL WHEN THE POOL IS OPEN.

LEARN LIFE SAVING TECHNIQUES.

### REMEMBER AND POST CLOSE TO THE SWIMMING POOL THE FIRST AID NUMBERS

- Fire station :
- Ambulance :
- Poisons centre:

. THIS COVER DOES NOT REPLACE THE GOOD SENSE NOR WITH THE INDIVIDUAL LIABILITY. THE PURPOSE OF THIS COVER DOES NOT REPLACE THE VIGILANCE OF THE PARENTS AND/OR THE RESPONSIBLE ADULTS WHICH REMAINS THE ESSENTIAL FACTOR FOR YOUNG CHILDREN PROTECTION.

. BEWARE: SAFETY IS ASSURED ONLY WITH ONE CLOSED COVER, LOCKED AND CORRECTLY INSTALLED IN ACCORDANCE WITH THE INSTRUCTIONS OF THE MANUFACTURER.

. THE COVER MUST BE SYSTEMATICALLY INSTALLED IN THE EVENT OF EVEN TEMPORARY ABSENCE OF THE RESIDENCE.

. MAKE SURE THERE IS NO BATHERS OR FOREIGN BODIES IN THE POOL BEFORE AND DURING CLOSING.

. PLACE THE NECESSARY TOOLS TO OPEN THE COVER OUT OF REACH CHILDREN. (THE KEY FOR EXAMPLE)

. THE OPENING ACTION OF THE MECHANISM SHOULD ONLY BE UNDERTAKEN BY A RESPONSIBLE ADULT.

. IT IS FORBIDDEN TO WALK OR JUMP ON THE SLATTED COVER.

. TAKE ALL MEASURES IN ORDER TO PREVENT THE ACCESS OF THE POOL TO YOUNG CHILDREN AND THIS UNTIL REPAIR OF THE COVER OR WHEN NOTICING A DYSFUNCTION PREVENTING CLOSING AND THE SECURITY OF THE POOL.

. A CHILD MIGHT DROWN IN LESS THAN 3 MINUTES, AT LEAST ONE ADULT MUST SUPERVISE THE POOL WHEN IT IS OPEN.



SWIMMING POOL BUILDER

ZA La basse croix rouge 35530 Brécé FRANCE - tel : +33 2 99 00 25 62 - fax : +33 2 99 04 28 70 - E-mail : [export@del-piscine.fr](mailto:export@del-piscine.fr)

